



JDV
CONTROL
VALVES



JSB-F / JSB-M Type V-Port Segment Control Valve



*We link all you need
and more than you expect.*



**JDV
CONTROL
VALVES**

JSB-F / JSB-M

V-Port Segment Control Valve

JSB Series V-segment valve is the segment ball with V-notch design for both regulating and shut-off services. The high valve capacity with optimum flow characteristics provides the ideal solution in flow control.

Industrial Fields:

Oil & Gas
Refinery / Petrochemical
Chemical
Pulp & Paper
Power Plant
Steel Mill
Food
Mining
Water Treatment



Product Features:

1. 1-PC Body design reducing the leakage.
2. V-segment design providing the large and straight path giving a high Cv even in case of fibers or particles.
3. Trunnion design with self-lubricating bearings making the torque lighter and life cycle longer.
4. V-notch in the segment offering a shearing function to allow fibrous mediums or slurries to pass without any obstruction.
5. Optional seat design meeting many applications.
6. Alternative hard faces satisfying numerous services.
7. Spring-loaded metal seat design providing a lower torque.
8. Removable end-cap making the maintenance easier.
9. Equal percentage flow characteristics.
10. Spline stem design reducing the deadband to optimizes the control performance.
11. Available in flangeless (wafer) or flanged connections.
12. ISO 5211 mounting pad.
13. Anti-static design.
14. Anti-blowout stem design.

Applications

1. Flow control.
2. Pressure control.
3. Slurries or viscous mediums.
4. Mediums containing powders or particles.
5. Mediums with chips or fibers, especially in the Pulp & Paper industry.

Design & Structure

Seat Options:

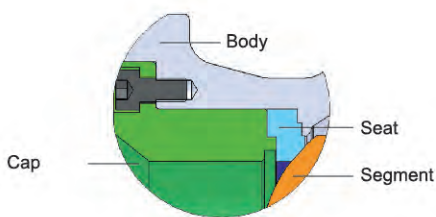

Soft Seat

Temp. : -20~356 °F (-29~180 °C)

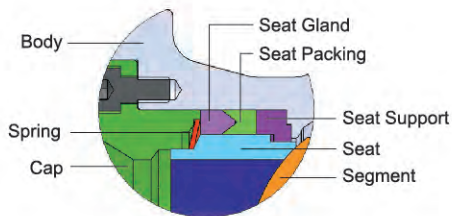

Metal Seat-S01 Type

Temp. : -20~661 °F (-29~350 °C)
Graphite seat packing design allowing higher temperature range.

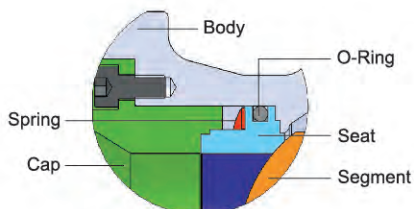

Metal Seat-S02 Type

Temp. : -20~446 °F (-29~230 °C)
FKM O-Ring design providing light torque to enhance the control performance.

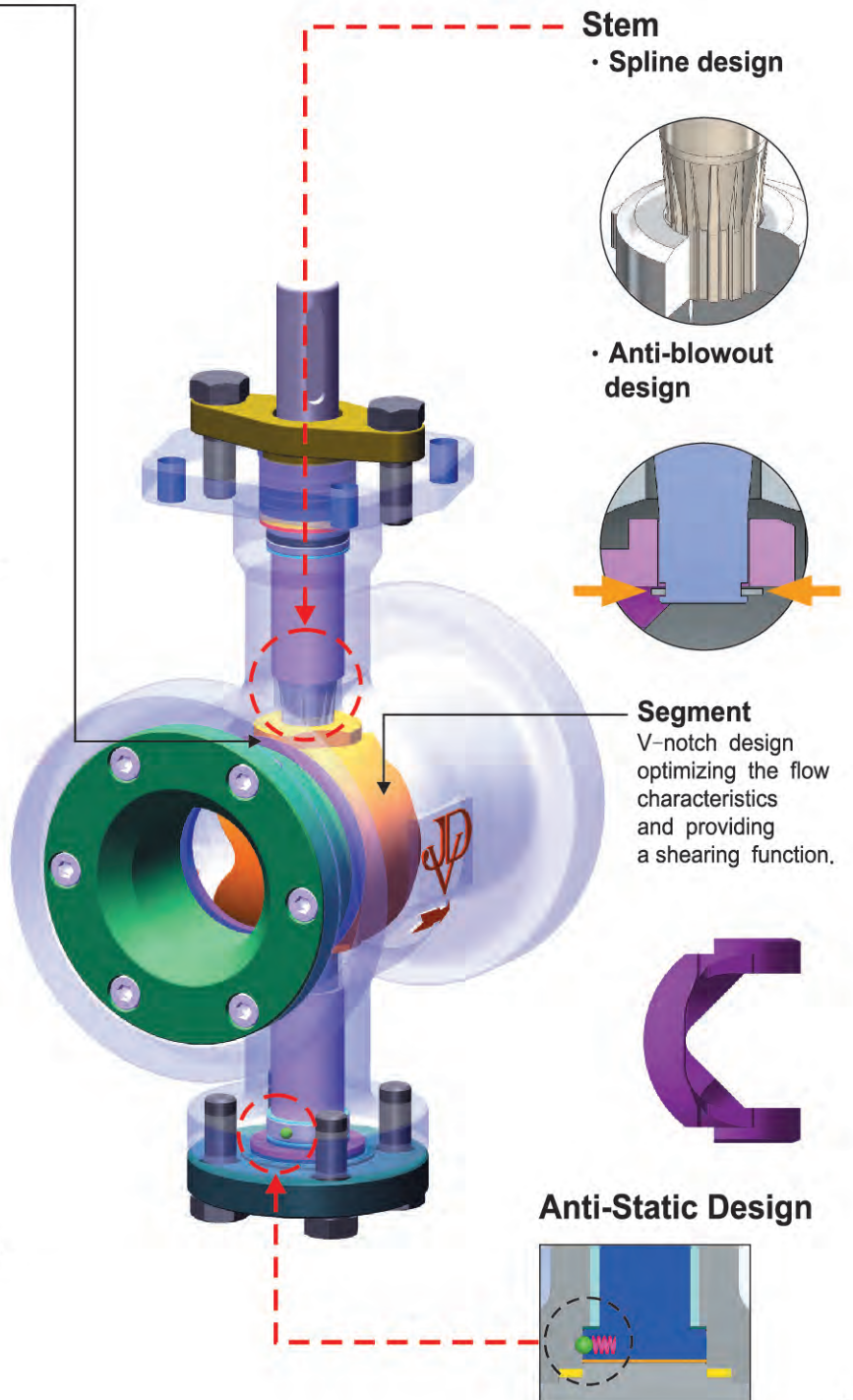

Stem

- Spline design

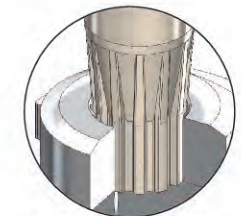

- Anti-blowout design

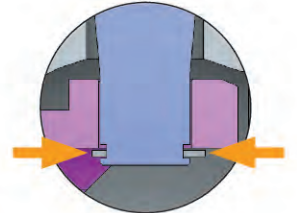

Segment

V-notch design optimizing the flow characteristics and providing a shearing function.



Anti-Static Design

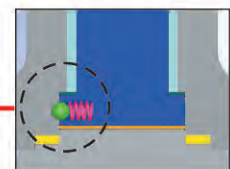



Applicable Standards

- Body Material : Standard in WCB, CF8, CF8M.
Other materials are available according to requirements.
- Nominal Size : 1" to 16" (DN25 to DN400)
- Pressure Rating : JIS 10K ASME CLASS 150/
300 DIN PN16/40
- End Connections : Flangeless /RF Flanged
- Range Ability : Greater than 150:1.
- Seat Leakage : ANSI/FCI70-2 /
Soft-seat : Class VI /
Metal-seat : Class IV
- Temperature Range : -20~661°F (-29~350°C)
- Face-to-face Dimensions : According to ISA S75.04
- Flanged Dimensions : JIS B2220 / ASME B16.5 / EN 1092-1

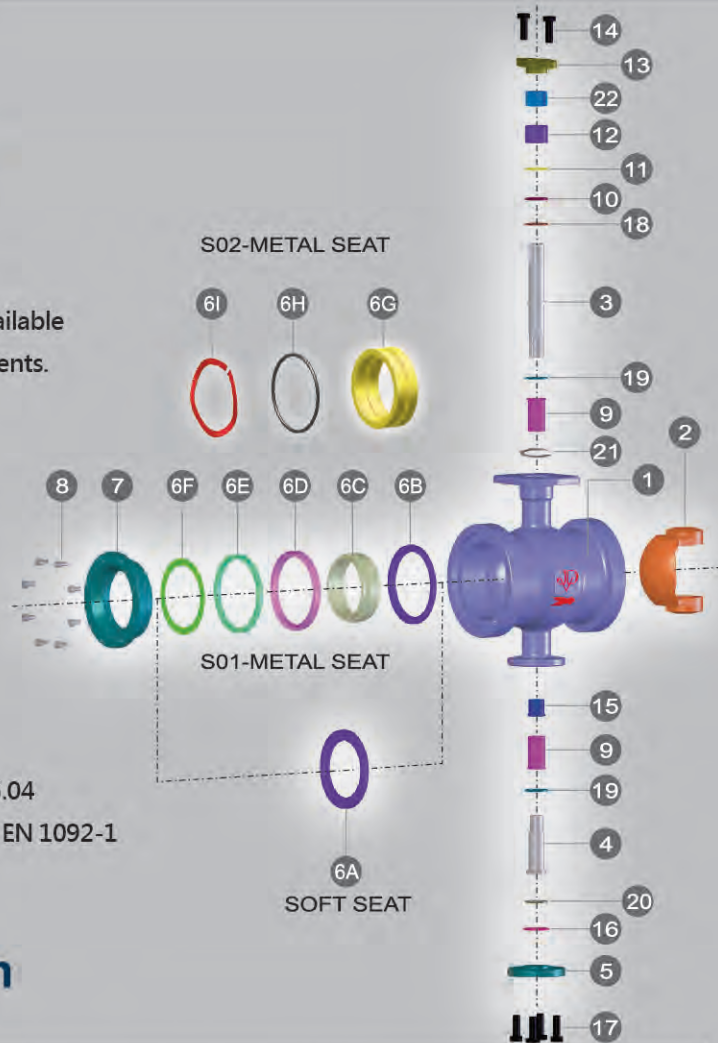

Technical Specification

STANDARD MATERIALS

NO		A216-WCB	A351-CF8	A351-CF8M
1	BODY	A216-WCB	A351-CF8	A351-CF8M
2-1	SEGMENT - SOFT SEAT	A351-CF8		
2-2	SEGMENT - METAL SEAT	A351-CF8+HCR ⁽¹⁾ / TC ⁽¹⁾		
3	STEM	A276-304		
4	SHAFT	A276-304		
5	END COVER	AISI-1045	A276-304	A276-316
SOFT SEAT	6A	SEAT G-PTFE		
S01 METAL SEAT	3	STEM A564-630(HH1150)		
	4	SHAFT A564-630(HH1150)		
	6B	SEAT SUPPORT A351-CF8		
	6C	SEAT A351-CF8+STELLITE® / TC		
	6D	PACKING GRAPHITE		
	6E	SEAT GLAND A351-CF8		
S02 METAL SEAT	6F	SPRING INCONEL® X-750		
	6G	SEAT A351-CF8+STELLITE®		
	6H	O-RING FKM		
	6I	SPRING INCONEL® X-750		
7	CAP	A351-CF8	A351-CF8M	
8	BOLT ⁽²⁾	304SS		
9	THURST BEARING	A240-316+PTFE/A240-316+HARD FACE		
10	WASHER	G-PTFE/GRAPHITE		
11	WASHER	A240-316+HARD FACE		
12	GLAND PACKING	G-PTFE/GRAPHITE		
13	GLAND	A351-CF8		
14	GLAND BOLT	304SS		
15	SUPPORT ⁽³⁾	A276-304	A-276-316	
16	COVER GASKET	G-PTFE/GRAPHITE		
17	COVER BOLT	304SS		
SOFT SEAT & S02 METAL SEAT	18	STEM O-RING ⁽⁴⁾ FKM		
19	WASHER	TFE COMP./A240-316+HARD FACE		
20	WASHER	TFE COMP./GRAPHITE		
21	C-CLIP	STAINLESS STEEL		
22	GLAND BEARING	G-PTFE / A240-316+PTFE		

NOTES: (1) HCR = Hard Chrome TC = Tungsten Carbide (2) For size 2" and above. (3) For size 2-1/2" and above. (4) Max temp 446 °F (230 °C)

The above materials may be changed with different using conditions.

TEMPERATURE & PRESSURE DIAGRAM

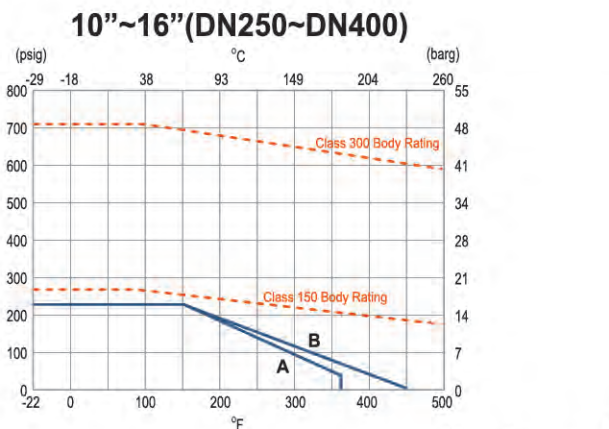
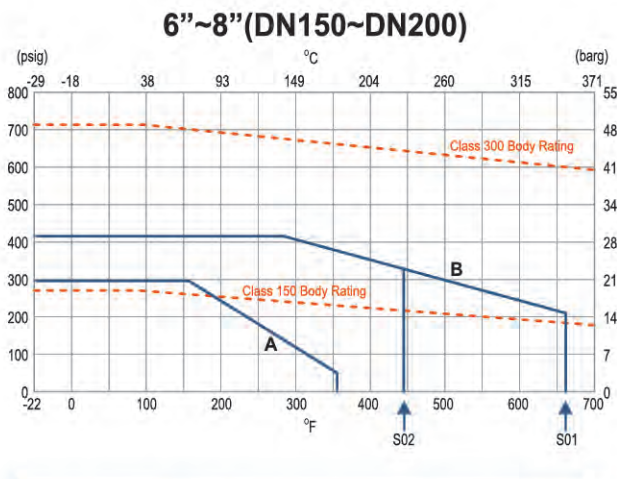
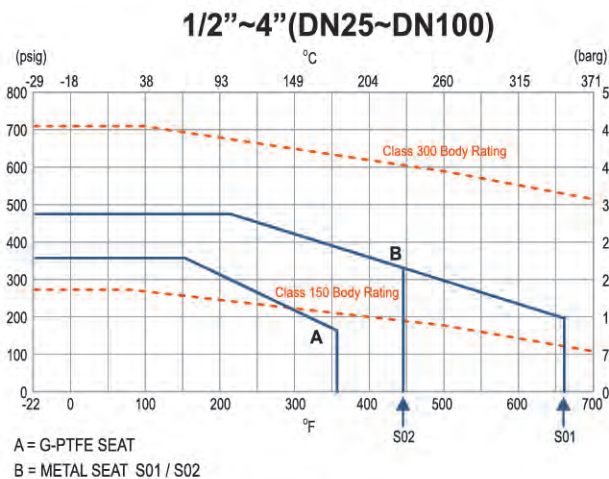

INHERENT FLOW CHARACTERISTICS

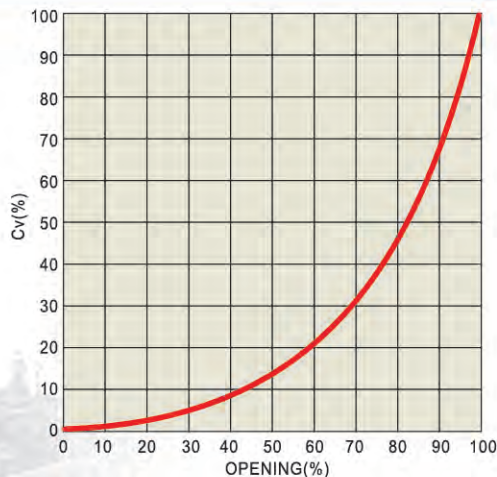

Cv VALUES

SIZE	OPENING %									
	10	20	30	40	50	60	70	80	90	100
1"	0.01	0.52	1.66	3.44	5.87	9.11	13.36	18.83	27.54	40.50
1-1/2"	0.02	1.06	3.35	6.95	11.85	18.38	26.96	38.00	55.55	81.70
2"	0.04	1.68	5.30	11.00	18.75	29.10	42.67	60.12	87.90	129.30
2-1/2"	0.06	2.79	8.80	10.23	31.10	40.26	70.78	99.74	145.86	214.50
3"	0.10	4.54	14.30	29.67	50.62	78.50	115.20	162.30	237.40	349.10
4"	0.15	6.57	20.70	43.00	73.30	113.70	166.80	235.00	343.70	505.50
5"	0.23	10.20	32.10	66.64	113.70	176.40	258.70	360.60	533.00	784.00
6"	0.38	16.70	52.70	109.30	186.50	289.50	424.54	598.20	874.80	1286.50
8"	0.50	21.90	69.00	143.00	244.10	378.90	555.68	783.00	1145.00	1683.90
10"	0.93	39.58	124.85	258.80	441.50	685.13	1004.80	1416.00	2040.00	3045.00
12"	1.29	55.96	176.50	366.00	624.20	968.60	1420.60	2001.80	2927.40	4305.00
14"	1.73	75.30	237.40	492.20	839.50	1302.00	1910.70	2663.40	3937.00	5790.00
16"	2.27	98.30	310.20	643.00	1097.00	1702.00	2497.00	3480.00	5145.00	7566.00

※ Above values are just for reference, and the exact values will be presented by the practical testing.



JDV CONTROL VALVES

FLANGELESS TYPE

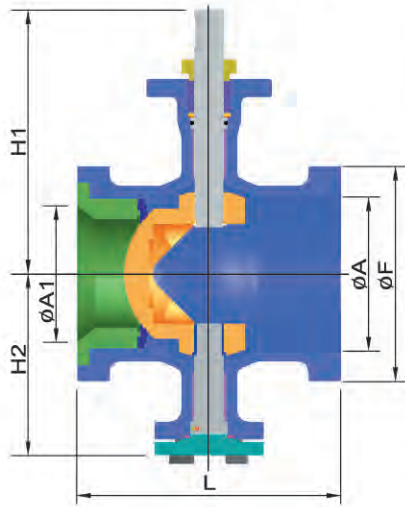

FLANGED TYPE

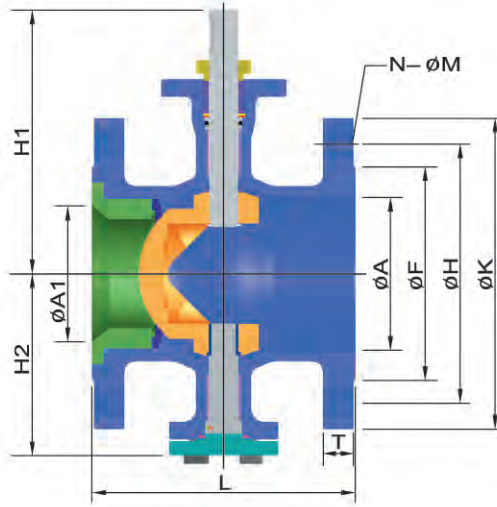

ISO MOUNTING PAD

1"~4"(DN25~DN100)

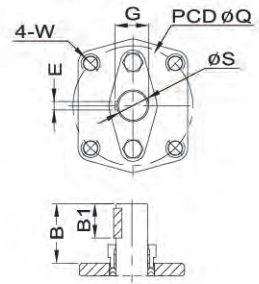

5"~10"(DN125~DN250)

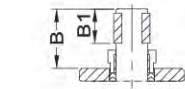
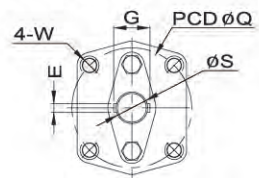

12"~16"(DN300~DN400)

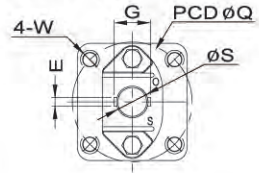

DIMENSIONS FOR FLANGELESS TYPE

(mm)

SIZE	A	A1	L	F	H1	H2	S	E	G	B	B1	Q	W	Wt (Kg)
25 1"	33	25	102	64	108	70	15.5	5	17.5	33	20	50	M6	2.5
40 1-1/2"	49	40	114	82	134	84	15.5	5	17.5	45	30	70	M8	3.75
50 2"	60	50	124	100	142	92	15.5	5	17.5	44	30	70	M8	4.8
65 2-1/2"	73	65	140*	118	151	101	15.5	6	17.5	45	30	70	M8	5.51
80 3"	89	80	165	131	164	112	22	8	25	45	30	70	M8	9.11
100 4"	113	100	194	158	194	134	22	8	25	51	30	102	M10	14.85
125 5"	140	125	254*	185	215	154	25	8	31	52	30	102	M10	25.9
150 6"	160	132	229	216	232	171	25	8	31	52	30	102	M10	28.22
200 8"	203	200	243	267	279	199	30	8	36	70	45	140	M16	45.2
250 10"	252	250	297	324	326	234	36.3	14	46.3	76	55	140	M16	75
300 12"	300	285	338	375	386	272	48	14	61	86	67	165	M20	125

Face-to-Face dimensions L according to ISA S75.04

*Not in ISA standard

DIMENSIONS FOR FLANGED TYPE (JIS 10K)

(mm)

SIZE	A	A1	L	F	JIS 10K					H1	H2	S	E	G	B	B1	Q	W	Wt (Kg)
					H	K	M	N	T										
25 1"	33	25	127	67	90	125	19	4	14	108	70	15.5	5	17.5	33	20	50	M6	3.7
40 1-1/2"	49	40	165	81	105	140	19	4	16	134	84	15.5	5	17.5	45	30	70	M8	5.8
50 2"	60	50	178	96	120	155	19	4	16	142	92	15.5	5	17.5	44	30	70	M8	7.5
65 2-1/2"	73	65	190	116	140	175	19	4	18	151	101	15.5	6	17.5	45	30	70	M8	11.8
80 3"	89	80	203	126	150	185	19	8	18	164	112	22	8	25	45	30	70	M8	12.8
100 4"	113	100	229	151	175	210	19	8	18	194	134	22	8	25	51	30	102	M10	23
125 5"	140	125	254	182	210	250	23	8	20	215	154	25	8	31	52	30	102	M10	31.5
150 6"	160	132	267	212	240	280	23	8	22	232	171	25	8	31	52	30	102	M10	38
200 8"	203	200	292	262	290	330	23	12	22	279	199	30	8	36	70	45	140	M16	62.5

Face-to-Face dimensions L according to JIS B 2002

DIMENSIONS FOR FLANGED TYPE (ASME CLASS 150/300)

(mm)

SIZE	A	A1	L	F	ASME CLASS 150					ASME CLASS 300					H1	H2	S	E	G	B	B1	Q	W	Wt (Kg)	
					H	K	M	N	T	H	K	M	N	T										CLASS 150	CLASS 300
25 1"	33	25	102	51	79.5	108	16	4	14.3	89	124	19	4	17.5	108	70	15.5	5	17.5	33	20	50	M6	3.4	5.8
40 1-1/2"	49	40	114	73	98.5	127	16	4	17.5	114.5	156	22	4	20.6	134	84	15.5	5	17.5	45	30	70	M8	5.4	8.9
50 2"	60	50	124	92	120.5	152	19	4	19.1	127	165	19	8	22.3	142	92	15.5	5	17.5	44	30	70	M8	7.2	12.8
65 2-1/2"	73	65	140*	105	139.5	178	19	4	22.3	149	190	22	8	25.4	151	101	15.5	6	17.5	45	30	70	M8	11	16
80 3"	89	80	165	127	152.5	190	19	4	23.9	168	210	22	8	28.6	164	112	22	8	25	45	30	70	M8	14.5	19.8
100 4"	113	100	194	157	190.5	229	19	8	23.9	200	254	22	8	31.8	194	134	22	8	25	51	30	102	M10	21.8	32.8
125 5"	140	125	254*	186	216	254	22	8	23.9	235	279.4	22	8	35.1	215	154	25	8	31	52	30	102	M10	30	42
150 6"	160	132	229	216	241.5	279	22	8	25.4	267.9	318	22	12	36.6	232	171	25	8	31	52	30	102	M10	36	51
200 8"	203	200	243	270	298.5	343	22	8	28.6	330	381	25	12	41.2	279	199	30	8	36	70	45	140	M16	59	86.5
250 10"	252	250	297	324	362	406	25	12	30.2	387.5	445	29	16	47.7	326	234	36.3	14	46.3	76	55	140	M16	98.6	143.3
300 12"	300	285	338	381	431.8	483	25	12	31.8	451	521	32	16	50.8	386	272	48	14	61	86	67	165	M20	165	210.6
350 14"	350	336	400	413	476.3	533	29	12	35	514.4	584	32	20	54	450	340	67	20	76	115	80	165	M20	255	340
400 16"	400	380	400	470	539.8	597	29	16	36.6	571.5	648	35	20	57	505	373	67	20	76	135	100	165	M20	340	450

Face-to-Face dimensions L according to ISA S75.04

*Not in ISA standard

DIMENSIONS FOR FLANGED TYPE (DIN PN16/40)

(mm)

SIZE	A	A1	L	DIN PN16						DIN PN40						H1	H2	S	E	G	B	B1	Q	W	Wt (Kg)		
				F	H	K	M	N	T	F	H	K	M	N	T										DIN PN16	DIN PN40	
25	1"	33	25	102	68	85	115	14	4	18	68	85	115	14	4	18	108	70	15.5	5	17.5	33	20	50	M6	5.5	5.5
40	1-1/2"	49	40	114	88	110	150	18	4	18	88	110	150	18	4	18	134	84	15.5	5	17.5	45	30	70	M8	8	8
50	2"	60	50	124	102	125	165	18	4	18	102	125	165	18	4	20	142	92	15.5	5	17.5	44	30	70	M8	13	13
65	2-1/2"	73	65	140*	122	145	185	18	8	18	122	145	185	18	8	22	151	101	15.5	6	17.5	45	30	70	M8	13.5	15
80	3"	89	80	165	138	160	200	18	8	20	138	160	200	18	8	24	164	112	22	8	25	45	30	70	M8	15	17
100	4"	113	100	194	158	180	220	18	8	20	162	190	235	22	8	24	193	134	22	8	25	51	30	102	M10	19.5	26
125	5"	140	125	254*	188	210	250	18	8	22	188	220	270	26	8	26	215	154	25	8	31	52	30	102	M10	30.5	36.7
150	6"	160	132	229	212	240	285	22	8	22	218	250	300	26	8	28	232	171	25	8	31	52	30	102	M10	36.5	41
200	8"	203	200	243	268	295	340	22	12	24	285	320	375	30	12	34	279	198	30	8	36	70	45	140	M16	54	76.5
250	10"	252	250	297	320	355	405	26	12	26	345	385	450	33	12	38	326	234	36.3	14	46.3	76	55	140	M16	99	133
300	12"	300	285	338	378	410	460	26	12	28	410	450	515	33	16	42	386	272	48	14	61	86	67	165	M20	155	191
350	14"	350	336	400	438	470	520	26	16	30	465	510	580	36	16	46	445	315	48	14	61	100	80	165	M20	240	320
400	16"	400	380	400	490	525	580	30	16	32	535	585	660	39	16	50	505	373	67	20	76	135	100	165	M20	320	440

Face-to-Face dimensions L according to ISA S75.04 *Not in ISA standard

HOW TO ORDER

JSB-F Soft Seat Ex: → **W1** → **04** → **C** → **G** → **03** → **050** → **A1**

A. SPECIFICATION	B. BODY MAT'L	C. SEGMENT MAT'L	D. SEAT MAT'L	E. STEM MAT'L	F. SIZE	G. OPTION
W1 FLANGELESS	02 WCB (1.0619)	A CF8 (1.4308)	G G-PTFE (15% GLASS FIBER+PTFE)	02 304 (1.4301)	025 1"	I LIVE LOADING
A1 JIS 10K	04 CF8 (1.4308)	C CF8M (1.4408)	S S-PTFE (50% SS316+PTFE)	03 316 (1.4401)	040 1-1/2"	H LEVER
C1 ASME CLASS 150	04 CF8M (1.4408)	D CF3 (1.4306)	T TFM-1600	05 317 (1.4449)	050 2"	G GEAR
C2 ASME CLASS 300	05 CF3 (1.4306)	E CF3M (1.4404)	E PEEK	07 304L (1.4306)	065 2-1/2"	A BARE SHAFT
D2 DIN PN16	06 CF3M (1.4404)	F CG8M (1.4412)		08 316L (1.4404)	080 3"	
D4 DIN PN40	07 CG8M (1.4412)	I CD3MN (1.4470)		10 S31803 (1.4462)	100 4"	
	15 CD3MN (1.4470)				125 5"	
					150 6"	
					200 8"	
					250 10"	
					300 12"	
					350 14"	
					400 16"	

JSB-M Metal Seat Ex: → **C1** → **04** → **C** → **7** → **050** → **A1** → **S01** → **HCR**

A. SPECIFICATION	B. BODY MAT'L	C. SEGMENT MAT'L	D. STEM MAT'L	E. SIZE	F. OPTION	G. TEMPERATURE
W1 FLANGELESS	02 WCB (1.0619)	A CF8 (1.4308)	02 304 (1.4301)	025 1"	I LIVE LOADING	S01 -20-661 °F (-29-350 °C)
A1 JIS 10K	04 CF8 (1.4308)	C CF8M (1.4408)	03 316 (1.4401)	040 1-1/2"	H LEVER	S02 -20-446 °F (-29-230 °C)
C1 ASME CLASS 150	04 CF8M (1.4408)	D CF3 (1.4306)	05 317 (1.4449)	050 2"	G GEAR	
C2 ASME CLASS 300	05 CF3 (1.4306)	E CF3M (1.4404)	07 304L (1.4306)	065 2-1/2"	A BARE SHAFT	
D2 DIN PN16	06 CF3M (1.4404)	F CG8M (1.4412)	08 316L (1.4404)	080 3"		H. HARD FACE
D4 DIN PN40	07 CG8M (1.4412)	I CD3MN (1.4470)	10 S31803 (1.4462)	100 4"		HCR SEGMENT W / HCR
	15 CD3MN (1.4470)		22 630 (1.4542)	125 5"		SEAT W / STELLITE®
				150 6"		TC SEGMENT W / TC
				200 8"		SEAT W / TC
				250 10"		
				300 12"		
				350 14"		
				400 16"		

HOW TO ORDER

※ Alternative materials are available on request.



■ HEADQUARTERS

No. 6-1, Qingnian Rd., Yangmei Dist., Taoyuan City 326, Taiwan
TEL +886-3-4965066 FAX +886-3-4963526 E-MAIL: sales@jdv.com.tw



Copyright 2021/05. All rights are reserved by JDV.
The technical data and content may be changed without prior notice.